

## Installing Solar Panel - With Velcro Strip (Recommended)

1. Clean solar panel surface at far ends first with supplied alcohol wipes and all to air dry.
2. Peel protective film off one side of supplied Velcro strip.
3. Place adhesive tape onto solar panel at far ends. Do not cover solar panel cells.
4. Press adhesive tape firmly onto solar panel surface and hold for 5 to 10 seconds to ensure proper bond.
5. Repeat previous steps for each Velcro strip and solar panel.
6. Apply supplied stickers onto the solar panel to seal any unused mounting holes.
7. Clean glass or mounting surface with supplied alcohol wipes and allow to air dry.
8. Peel protective film off from the other side of the supplied Velcro strips.
9. Position solar panel on motor side of the shade and in a location on the window surface that ensures adequate light exposure.
10. Press firmly onto and hold for 5 to 10 seconds to ensure that it has been attached securely.
11. Connect cable adapter into the solar panel, then connect solar panel cable to motor cable.

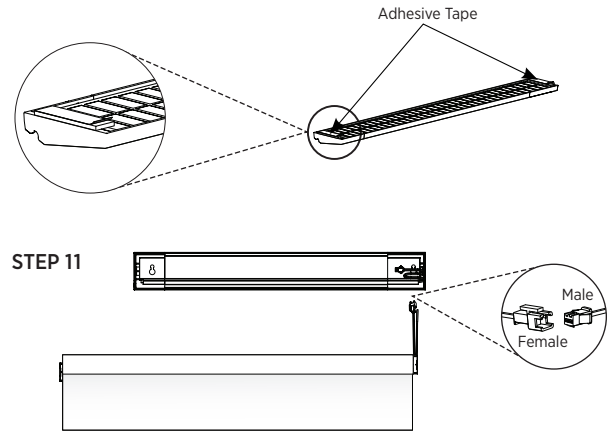

## Installing Solar Panel - With Mounting Bracket (Optional)

1. Break off excess bracket length with pliers (if necessary).
2. Install mounting bracket to window frame or mounting surface on motor side of shade in a location that ensures adequate light exposure using the provided screw and anchors (or similar if substrate calls for a different screw type) to secure the mounting bracket to the mounting surface. Please note that the mounting bracket requires 1" of depth and should be installed at 5.5" over from the side of the window frame (see diagram for acceptable mounting positions).
3. Attach solar panel to mounting bracket using provided screw.
4. Apply supplied stickers onto the solar panel to seal any unused mounting holes.
5. Connect cable adapter into the solar panel, then connect solar panel cable to motor cable.

STEP 1

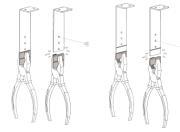

STEP 3

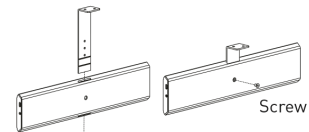

STEP 4

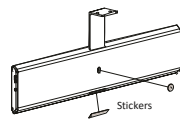

STEP 5

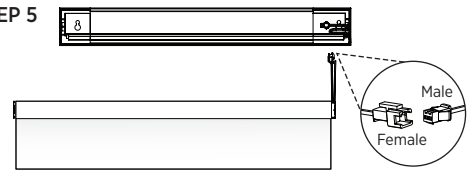

## Solar Panel Placement

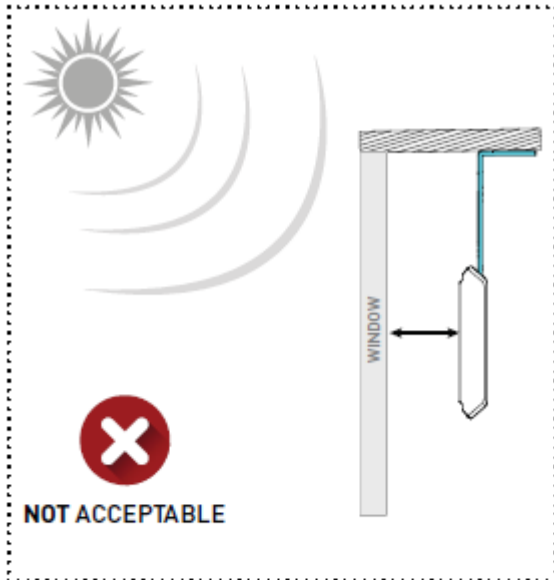

Solar panel should not be too far from the window because the performance will be reduced.



Keep the solar panel as close to the window as possible.

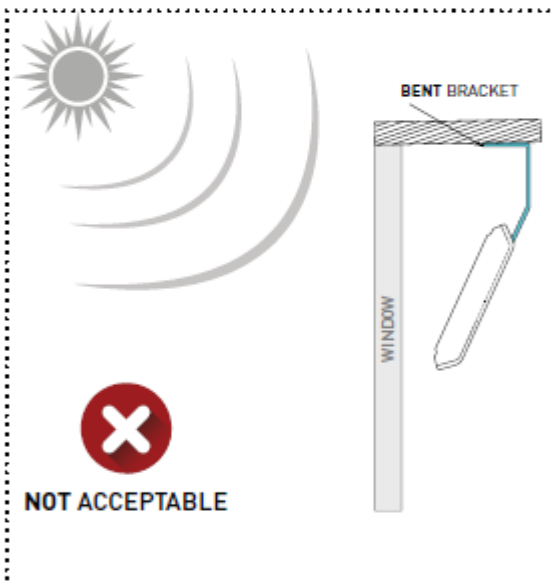

The back of the bracket should not be facing opposite to the window.



The back of the bracket should be facing towards the window.