

ECONO BLACKOUT + ECONO SOLAR SHADES INSTALLATION INSTRUCTIONS

SIMPLY FOLLOW OUR STEP-BY-STEP INSTRUCTIONS AND YOUR BEAUTIFUL NEW SHADES WILL SOON BE ENHANCING YOUR HOME OR WORKSPACE FOR MANY YEARS TO COME.

Getting Started:

Carefully unpack your shades and check to make sure you have the following installation parts. We recommend reading through these instructions before starting the installation.

Parts Included:

- Screws
- Two mounting brackets
- Tension Device

Please note that your brackets must be securely attached to the mounting surface. If your screws do not hit wood studs you'll have to use a different fastener which can be found at any local hardware store.

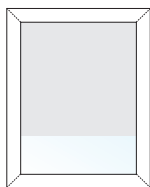

INSIDE MOUNT

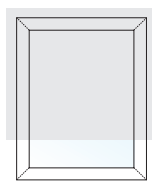

OUTSIDE MOUNT

Tools You Will Need:

- Drill with a 1/8" bit & a Phillips bit
- Phillips screwdriver
- Metal tape measure

* According to the Window Covering Manufacturers Association Inc., all labels must not be removed from the product.

* To comply with child safety standards, all tension devices must be installed per the installation instructions provided in step 3

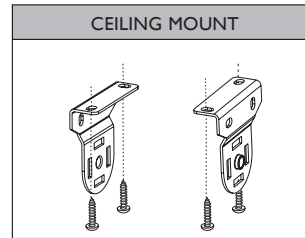

CEILING MOUNT

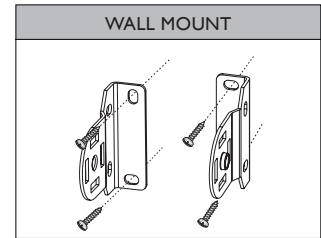

WALL MOUNT

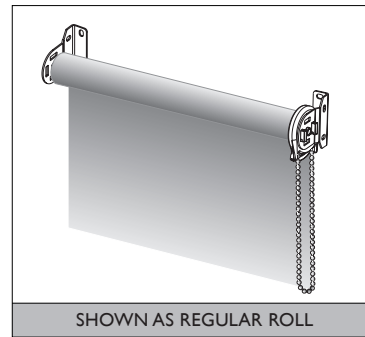

SHOWN AS REGULAR ROLL

IA. Installing Your Brackets:

Inside Mount: Attach the brackets to the window frame, window molding, wall or ceiling, as shown. Brackets are universal so clutch may be mounted on either side. There are 3 easy ways to install brackets. Choose which is best suited for your situation.

INSTALL BRACKETS UPWARD

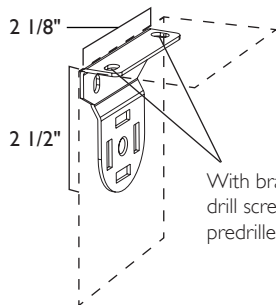

With bracket in place drill screws through predrilled holes to secure.

INSTALL BRACKETS STRAIGHT ON

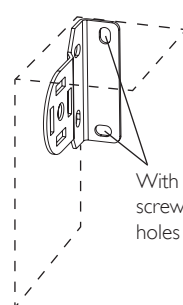

With bracket in place drill screws through predrilled holes to secure.

SHALLOW DEPTH BRACKET INSTALLATION

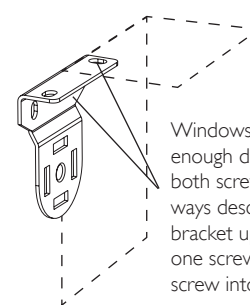

Windows that do not have enough depth to install both screws in one of the ways described; position bracket upward and install one screw upwards and screw into side of bracket.

* Please note for thicker fabrics or longer lengths, we may provide an "extension" bracket to accommodate a larger roll diameter. In this case, the measurement from the "foot" to the curved area of the bracket would be 2 7/8".

ECONO BLACKOUT + ECONO SOLAR SHADES INSTALLATION INSTRUCTIONS (CONTINUED)

SIMPLY FOLLOW OUR STEP-BY-STEP INSTRUCTIONS AND YOUR BEAUTIFUL NEW SHADES WILL SOON BE ENHANCING YOUR HOME OR WORKSPACE FOR MANY YEARS TO COME.

1B. Installing Your Brackets:

Outside Mount: Fit the shade into the brackets and center the shade over the window (this may take two people). With a pencil mark the wall on the side of one bracket. Remove shade and then attach the one bracket with two screws. Next, insert the shade into the second bracket. Hold shade up and insert other end into the already mounted bracket making sure that the shade is level. Mark the wall on the side of the second bracket. Remove shade, install second bracket with two screws.

* Please note for thicker fabrics or longer lengths, we may provide an "extension" bracket to accommodate a larger roll diameter. In this case, the measurement from the "foot" to the curved area of the bracket would be 2 7/8".

OUTSIDE WINDOW CASING/FRAME MOUNT

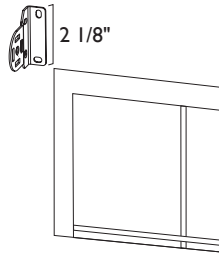

OUTSIDE WALL MOUNT

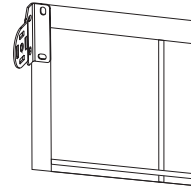

CEILING MOUNT



2. Inserting the Shade:

With the brackets now installed, you may install your shade.

Step A: Put the spring loaded pin end into the round hole of the bracket. Pushing the pin end towards its bracket, insert the hooks on the clutch side straight into the two slots in the bracket.

Step B: Once the two hooks are through the slots, gently pull down on the clutch until the two hooks have locked securely to the bracket. The bottom of the clutch should point straight down.

* Please note: Roller shades are not meant to be lowered past the ordered length. The shade will come with additional material that is automatically added in length to conceal the roller tube and to help secure the fabric on the roll. We have attached metal ball stops on the chain to prevent the shade from being raised or lowered past its limits.

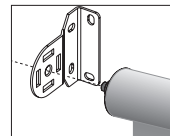

STEP A

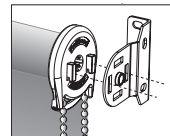

STEP B

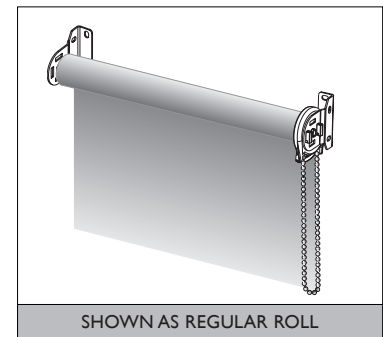

3. Installing Tension Device (Continuous Loop Control):

Consider Position of Tension Device:

The tension device should be positioned on the window frame or the wall so that the tension device and bead chain does not interfere with operation of window treatment.

The tension device should be installed so that bead chain is taut without stretching or pulling down on it. Stretching the bead chain will cause excessive wear. Do not twist or cross the bead chain.

Install Tension Device:

Press and hold the back spring on the tension device that is pre-installed at the top of the continuous loop. With the spring held, slide the device down to the bottom of the loop to where you would like the device positioned.

Insert and secure the two screws through the holes in the device. The loop should now pass freely through the tension device.

Please Note: When attaching to wood, included screws can be screwed directly into wood. When attaching to drywall and metal, use anchors that are designed for such substrates. Visit your local hardware store for guidance on appropriate anchors for your substrate.

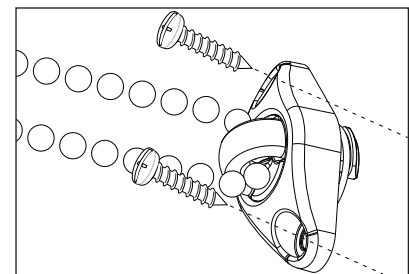

Care and Cleaning:

Minimal care and cleaning is needed to maintain the beauty of your shades. **To vacuum:** Use a hand held, low suction vacuum. **To dust:** Use a soft, clean cloth or a feather duster.

Warranty:

The Shade Store products are covered by a limited lifetime warranty. This warranty covers any defects in materials or workmanship so long as the product is measured and installed according to instructions. Every Shade Store window treatment is designed to provide trouble-free use. In the unlikely event that warranty service is ever needed, simply contact customer care at help@theshadestore.com or 800-754-1455 for assistance.