

DOUBLE ROLLER SHADES INSTALLATION INSTRUCTIONS

SIMPLY FOLLOW OUR STEP-BY-STEP INSTRUCTIONS AND YOUR BEAUTIFUL NEW SHADES WILL SOON BE ENHANCING YOUR HOME OR WORKSPACE FOR MANY YEARS TO COME.

Getting Started:

Carefully unpack your shades and check to make sure you have the following installation parts. We recommend reading through these instructions before starting the installation.

Parts Included:

- Screws
- Mounting brackets
- Tension Device
- Locking Tab

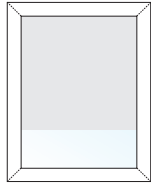

INSIDE MOUNT

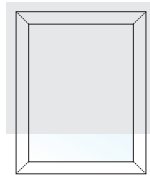

OUTSIDE MOUNT

Tools You Will Need:

- Drill with a 1/8" bit & a Phillips bit
- Phillips screwdriver
- Metal tape measure

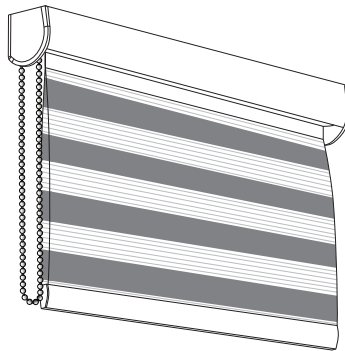

* According to the Window Covering Manufacturers Association Inc., all labels must not be removed from the product.

* To comply with child safety standards, all tension devices must be installed per the installation instructions provided in step 4.

I. Select Mount Type:

Mount the brackets to the wall or window frame, with the outside brackets no further than 2 inches (5 cm) from the ends of the headrail. On wide shades, space the additional bracket(s) at equal intervals. Use 2 screws per bracket.

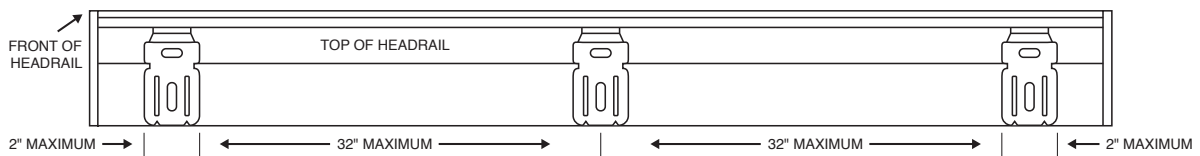

Inside Mount:

For inside or ceiling mounts, use the top bracket holes.

Make sure the release tab is always mounted on the bottom.

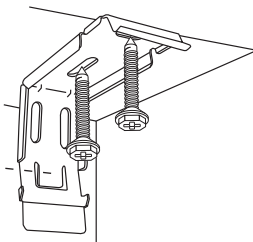

Outside Mount:

For wall or outside mounts, use the rear bracket holes.

Make sure the release tab is always mounted on the bottom.

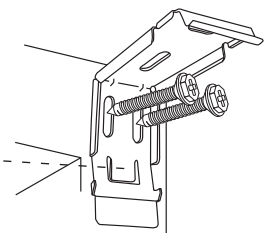

Please note that your brackets must be securely attached to the mounting surface. If your screws do not hit wood studs you'll have to use a different fastener which can be found at any local hardware store.

DOUBLE ROLLER SHADES INSTALLATION INSTRUCTIONS (CONTINUED)

SIMPLY FOLLOW OUR STEP-BY-STEP INSTRUCTIONS AND YOUR BEAUTIFUL NEW SHADES WILL SOON BE ENHANCING YOUR HOME OR WORKSPACE FOR MANY YEARS TO COME

2. Mount the Headrail:

Position the headrail with the front panel (A) resting on the top lip of all brackets. Push the bottom front of the headrail firmly backwards and toward the window until the lip on the rear of the headrail engages the bracket and snaps into place, (B) as shown.

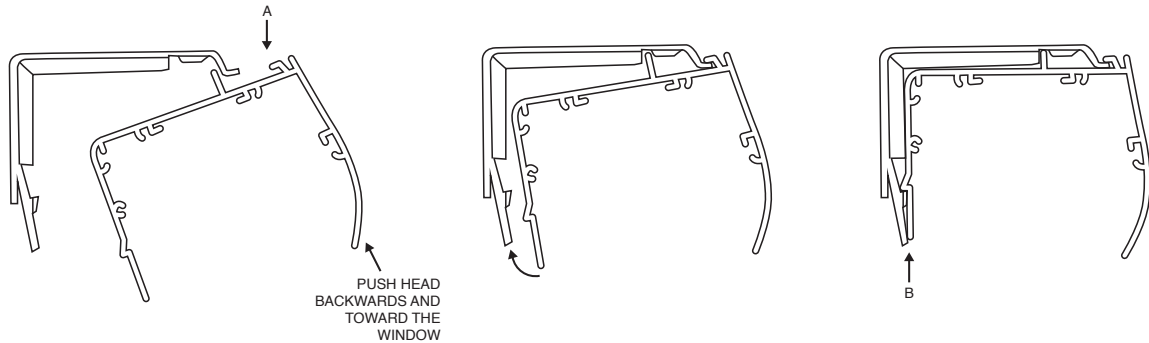

Please note: Roller Shades are not meant to be lowered past the ordered length. The shade will come with additional material that is automatically added in length to conceal the roller tube and to help secure the fabric on the roll.

3. Install Locking Tab to Bracket (Outside Mount Only):

Once the shade is installed, place the locking tab flat against the wall in line with the bracket on control side. Press locking tab upwards until you hear a click.

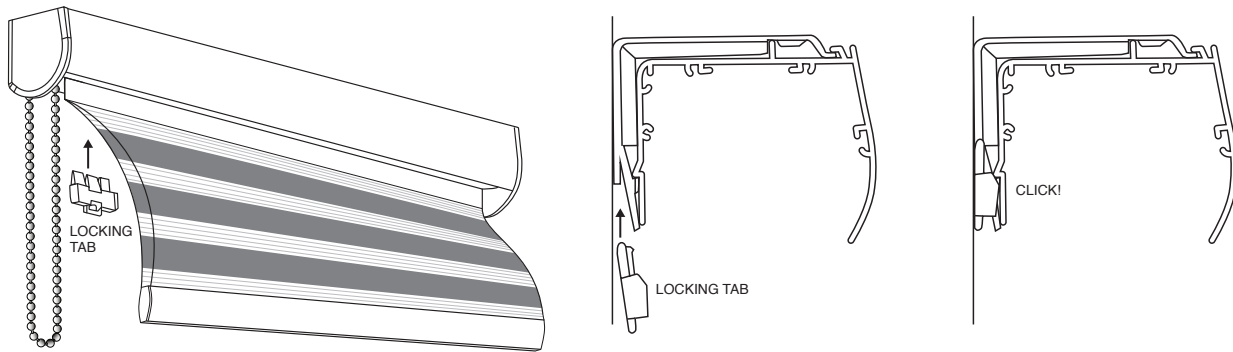

4. Installing Tension Device (Continuous Loop Control):

Positioning Tension Device:

The tension device should be positioned on the window frame or the wall so that the tension device and bead chain does not interfere with operation of window treatment.

4a. Begin Installation:

First slide the tension device to the bottom of the bead chain.

While holding the tension device in one hand, pull the plunger away from the bead chain with the other hand. Lift the bead chain out of the bead locking groove (Figure 1) and slide the tension device to the bottom of the chain loop.

Pull the tension device down until the bead chain is fully tensioned (plunger [Figure 2] will be at the top) and then move the tension device up approximately 1/8" (3mm).

Mark the screw hole locations on the wall with a pencil. (Figure 1)

Please Note: When attaching to wood, included screws can be screwed directly into wood. When attaching to drywall and metal, use anchors that are designed for such substrates. Visit your local hardware store for guidance on appropriate anchors for your substrate.

Continue to 4b. when installing tension device only or 4c. if installing with bracket.

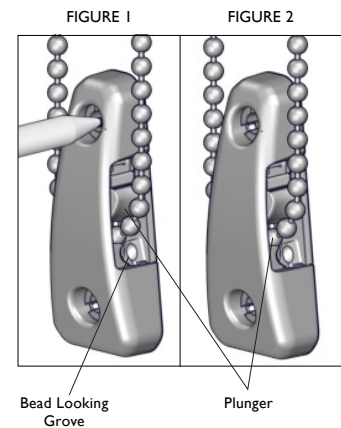

DOUBLE ROLLER SHADES INSTALLATION INSTRUCTIONS (CONTINUED)

SIMPLY FOLLOW OUR STEP-BY-STEP INSTRUCTIONS AND YOUR BEAUTIFUL NEW SHADES WILL SOON BE ENHANCING YOUR HOME OR WORKSPACE FOR MANY YEARS TO COME

4b. Installing Tension Device Only

Attach tension device to wall by installing larger provided screws into tension device holes. (Figure 3)

FIGURE 3



4c. Using A Bracket:

Remove tension device to reveal pencil marks. Align mounting bracket notches (Figure 4A, 5A) over pencil marks.

Next, attach bracket to wall by installing larger provided screws into mounting bracket oval slots.

Press the tension device onto the mounting bracket posts (Figure 4A, 5A). Carefully install the 2 small screws provided, through the tension device into the mounting bracket using a Phillips head screwdriver (Figure 4B, 5B)

Inside Mount

FIGURE 4A

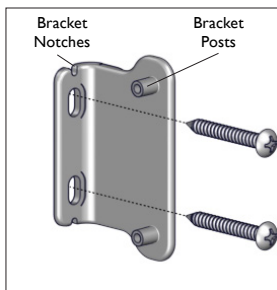

Outside Mount with Bracket

FIGURE 4B

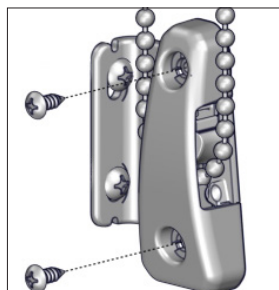
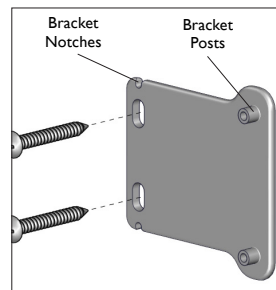
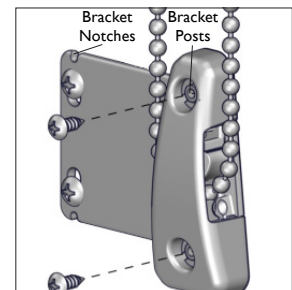

FIGURE 5A



Side Mount with Bracket

FIGURE 5B



5. Removing the Shade:

Use a screwdriver to push the bottom of the bracket backwards, away from the headrail. Once the headrail is released from the bottom of the bracket lift upward to unhook from the top of the bracket. Remove the locking tab with a screwdriver first if you have an outside mount.

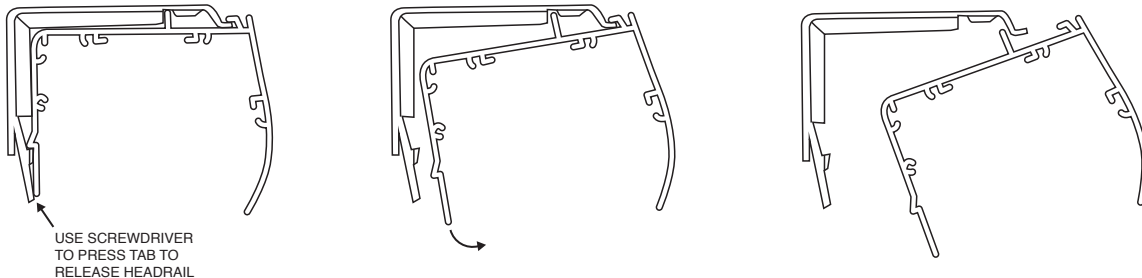

Care and Cleaning:

Minimal care and cleaning is needed to maintain the beauty of your shades. To vacuum: Use a hand held, low suction vacuum. To dust: Use a soft, clean cloth or a feather duster.

Warranty:

The Shade Store products are covered by a limited lifetime warranty. This warranty covers any defects in materials or workmanship so long as the product is measured and installed according to instructions. Every Shade Store window treatment is designed to provide trouble-free use. In the unlikely event that warranty service is ever needed, simply contact the Help Desk at help@theshadestore.com or 800-754-1455 for assistance.

THIS PAGE
INTENTIONALLY
LEFT BLANK