

2" METAL BLINDS INSTALLATION INSTRUCTIONS

SIMPLY FOLLOW OUR STEP-BY-STEP INSTRUCTIONS AND YOUR BEAUTIFUL NEW BLINDS WILL SOON BE ENHANCING YOUR HOME OR WORKSPACE FOR MANY YEARS TO COME.

Getting Started:

Carefully unpack your blinds and check to make sure you have the following installation parts. We recommend reading through these instructions before starting the installation.

Parts Included:

- Screws
- Two mounting brackets
- Auxiliary support bracket (if required)
- Wand
- 2 Valance clips
- Metal valance slat

Tools You Will Need:

- Drill with a 1/8" bit
- A Phillips bit
- Flathead screwdriver
- Metal tape measure

Please note that your brackets must be securely attached to the mounting surface. If your screws do not hit wood studs you'll have to use a different fastener which can be found at any local hardware store.

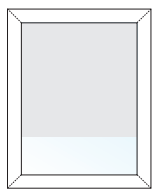

INSIDE MOUNT

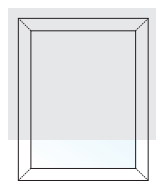

OUTSIDE MOUNT

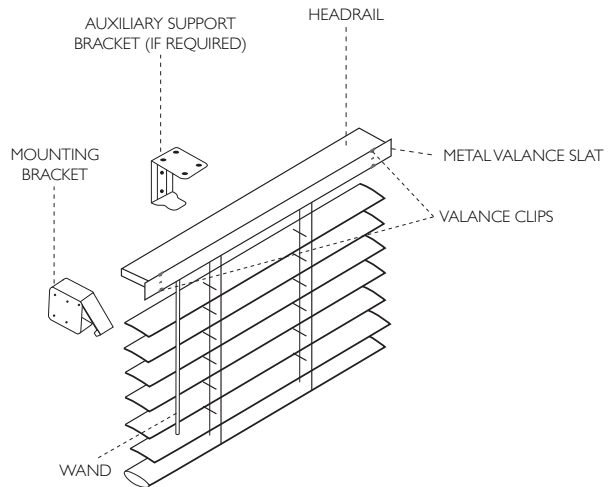

* According to the Window Covering Manufacturers Association Inc., all labels must not be removed from the product.

1. Installation Instructions:

Unwrap the blind. Do not untie cord at this time. Hold the blind against the window to determine the proper placement. It will either fit inside the window casing (inside mount) or outside the window casing or wall (outside mount). This will determine where and how your installation brackets should be attached.

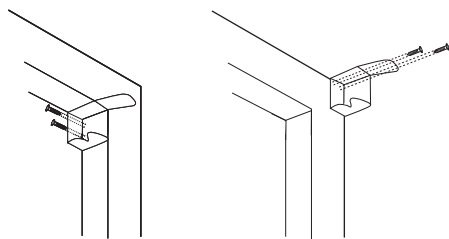

INSIDE MOUNT

OUTSIDE MOUNT

Inside Mount: Make certain the headrail is level and clear of obstructions. Make pencil marks 1/8" below the headrail on each end. The bottom of the installation brackets will be placed on these marks.

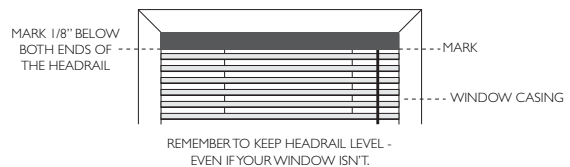

REMEMBER TO KEEP HEADRAIL LEVEL - EVEN IF YOUR WINDOW ISN'T.

Outside Mount: Hold the blind level and center against the window casing or wall. Mark the casing/wall with a pencil just below the headrail on each end. Also mark the window casing/wall 1/8" beyond the ends of the headrail. The installation brackets will be placed on these marks.

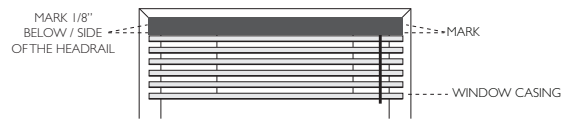

REMEMBER TO KEEP HEADRAIL LEVEL - EVEN IF YOUR WINDOW ISN'T.

2. Mounting Installation Brackets:

The brackets may be mounted using two screws in several different orientations depending on your needs:

- Inside the jambs (inside mount)
- To the outside of the window casing or wall (outside mount)
- Overhead: Either to the top inside of the window frame (inside mount) or to the ceiling (outside mount).

Open the bracket's swivel cover with a screwdriver. Hold the bracket against the mounting surface and align it with the pencil marks. Using a pencil, mark the location of the two diagonal holes for the mounting screws at least 1/4" from the edge of the wood. If auxiliary support brackets have been supplied go to step 2A.

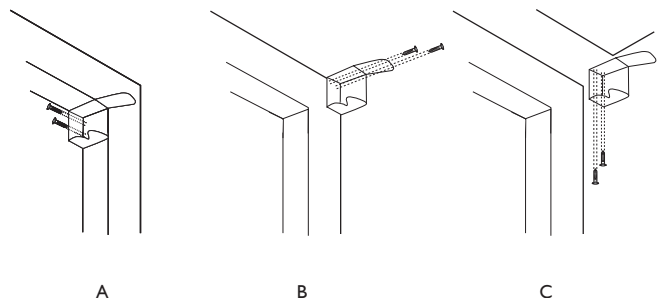

2" METAL BLINDS INSTALLATION INSTRUCTIONS (CONTINUED)

SIMPLY FOLLOW OUR STEP-BY-STEP INSTRUCTIONS AND YOUR BEAUTIFUL NEW BLINDS WILL SOON BE ENHANCING YOUR HOME OR WORKSPACE FOR MANY YEARS TO COME.

2A. Auxiliary Support Brackets (If Required):

If an auxiliary support bracket is included with your blind it should be placed in line with the installation brackets. The auxiliary support should not be in line vertically with the blind's cord or ladder as it may interfere with the blind's lifting and tilting mechanism.

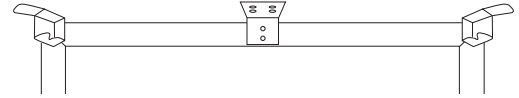

3. Headrail Installation:

With brackets installed, insert the headrail into the mounting brackets.

* If your blind is not fitting snugly left to right, open the mounting brackets, remove the headrail and pry out the tab at the end of the headrail with a screwdriver.

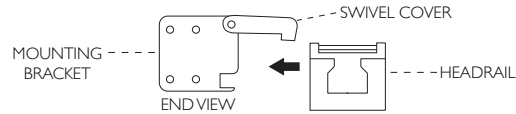
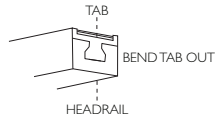

CLOSE THE SWIVEL COVERS TO LOCK HEADRAIL IN PLACE.

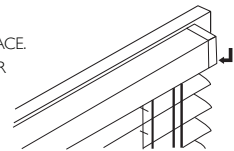
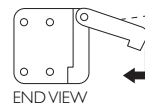

4. Valance Installation

Step 1: Attach each Valance Clip to the headrail by sliding it downward onto the headrail.

Step 2: Once the Valance Clip has been attached, insert the Metal Valance Slat onto the Valance Clip.

To do so, start by inserting the bottom of the Metal Valance Slat into the clip. Once the bottom has been inserted, insert the top of the slat into the clip.

Side View

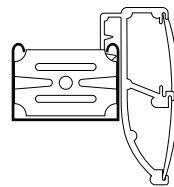

Step 1

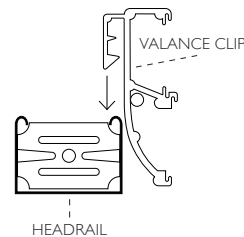

Step 2

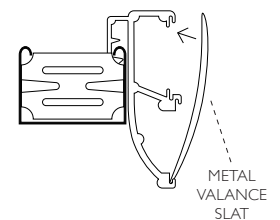

5. Wand Attachment

Attach the wand to hook and slide sleeve down to trap wand in place. You will now be able to adjust the angle of the slats by turning the wand.

CAUTION: Do not continue to turn the wand after it starts to bind as this may damage the tilt mechanism.

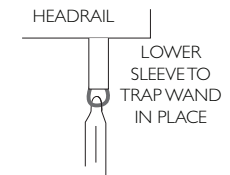
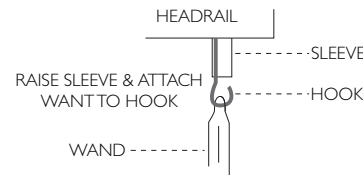

Care and Cleaning:

If the blind is dusty, simply vacuum over it using an upholstery attachment. For cleaning soiled spots, we recommend contacting customer care.

Warranty:

The Shade Store products are covered by a limited lifetime warranty. This warranty covers any defects in materials or workmanship so long as the product is measured and installed according to instructions. Every Shade Store window treatment is designed to provide trouble-free use. In the unlikely event that warranty service is ever needed, simply contact customer care at help@theshadestore.com or 800-754-1455 for assistance.