

PANEL SYSTEM INSTALLATION INSTRUCTIONS

SIMPLY FOLLOW OUR STEP-BY-STEP INSTRUCTIONS AND YOUR BEAUTIFUL NEW SHADES WILL SOON BE ENHANCING YOUR HOME OR WORKSPACE FOR MANY YEARS TO COME.

1. Preparing to Install the Panel System:

We recommend reading through these instructions before starting the installation. After removing panel system from its packaging, ensure you have all the parts needed for installation. Do not dispose of the packaging until installation is complete. As with most installations of this type, a secure attachment to the mounting surface is required. All bracket-mounting screws must screw into wood. If your particular installation requires you to mount the brackets to a surface other than wood, be sure to use the appropriate fasteners. These can be purchased at your local hardware store.

* According to the Window Covering Manufacturers Association Inc., all labels must not be removed from the product.

* To comply with child safety standards, all tension devices must be installed per the installation instructions provided in step 4.

2. Bracket Attachment:

Inside Mount: The brackets must be located 4" in from the ends of the track. You must have a minimum of 1" of space from the center of the hole on the bracket and the window (or window hardware) for two and three channel track. The four and five channel track require a minimum of 1 5/8" distance from the center of the hole to the window (or window hardware). The minimum distance will ensure the panels will have enough room to open and close. Attach the brackets with the screws provided ensuring brackets are in line. If the panel track requires more than two brackets, locate the extra bracket and evenly space between the two brackets.

Outside Mount: Locate the position of the headrail over the window. Mark the location of the ends of the headrail on the wall. Attach the extension brackets on the wall 4" in from the ends of the headrail. Make sure the brackets are level with each other. If the panel track requires more than two brackets, locate the extra bracket and evenly space between the two end brackets.

* Please note that your brackets must be securely attached to the mounting surface. If your screws do not hit wood studs you'll have to use a different fastener which can be found at any local hardware store.

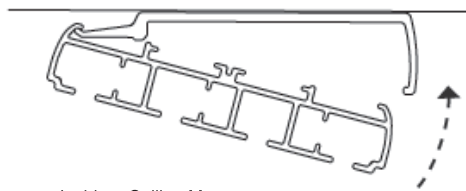

Inside + Ceiling Mount

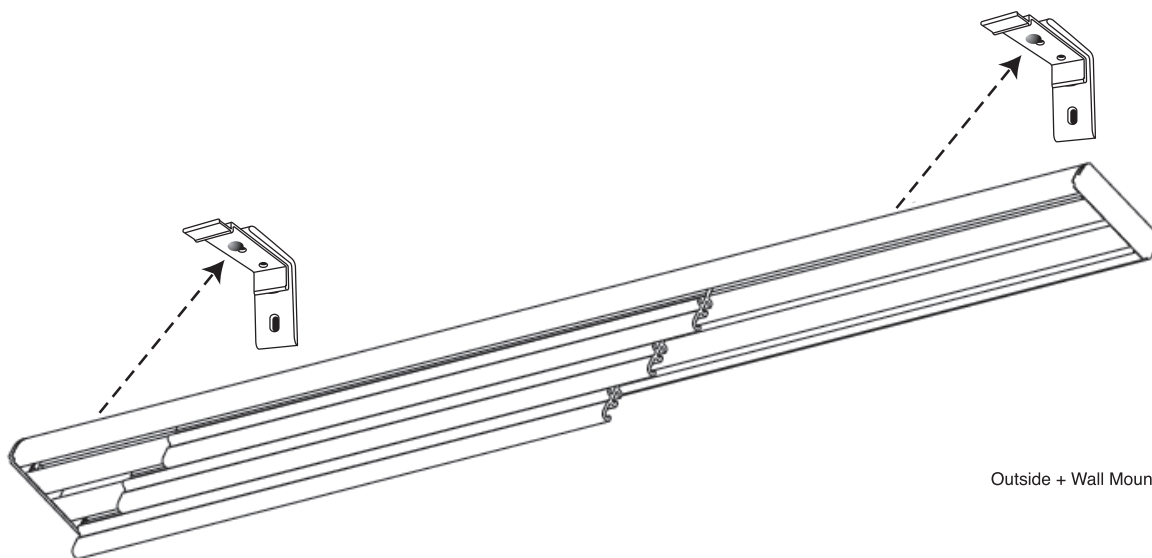

Outside + Wall Mount

PANEL SYSTEM INSTALLATION INSTRUCTIONS (continued)

SIMPLY FOLLOW OUR STEP-BY-STEP INSTRUCTIONS AND YOUR BEAUTIFUL NEW SHADES WILL SOON BE ENHANCING YOUR HOME OR WORKSPACE FOR MANY YEARS TO COME.

3. Attaching the Panels:

Pull forward on the bottom of the front panel carrier and pushing back on the bottom of the back panel carrier; slide the back carrier from behind the front carrier (Fig. 1). Repeat this action for the number of panels on your headrail. Align the velcro strip at the top of the panel with the velcro strip on the front face of the panel carrier line. Beginning at one end press the velcro strips together across the panel carrier. Be sure to go back and press the velcro to ensure a secure attachment (Fig. 2 & 3) repeat this step until all panels are attached. After all panels have been installed, return the carriers to their original positions (Fig 4). Once finished the panels should overlap (Fig 5).

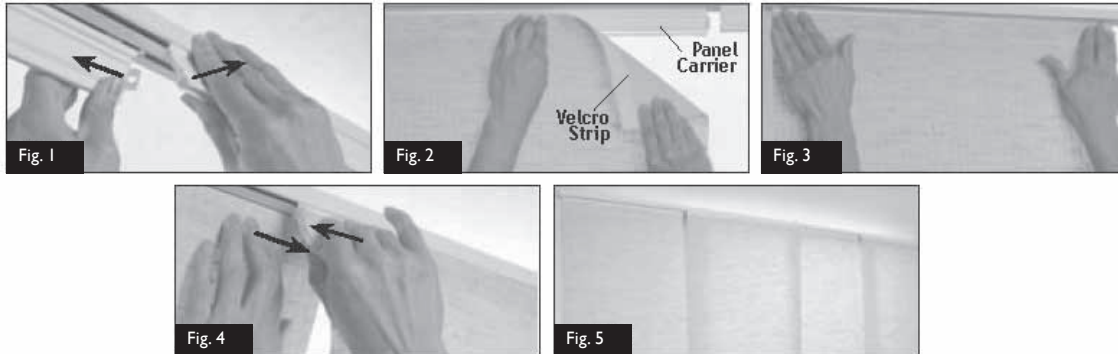

4. Installing Tension Device (Continuous Loop Control):

Positioning Tension Device:

The tension device should be positioned on the window frame or the wall so that the tension device and cord does not interfere with operation of window treatment.

4a. Begin Installation:

First slide the tension device to the bottom of the cord.

While holding the tension device in one hand, pull the plunger away from the cord with the other hand. Lift the cord out of the locking groove (Figure 1) and slide the tension device to the bottom of the cord loop.

Pull the tension device down until the cord is fully tensioned (plunger [Figure 2] will be at the top) and then move the tension device up approximately 1/8" (3mm).

Mark the screw hole locations on the wall with a pencil. (Figure 1)

Please Note: When attaching to wood, included screws can be screwed directly into wood. When attaching to drywall and metal, use anchors that are designed for such substrates. Visit your local hardware store for guidance on appropriate anchors for your substrate.

Continue to 4b. when installing tension device only or 4c. if installing with bracket.

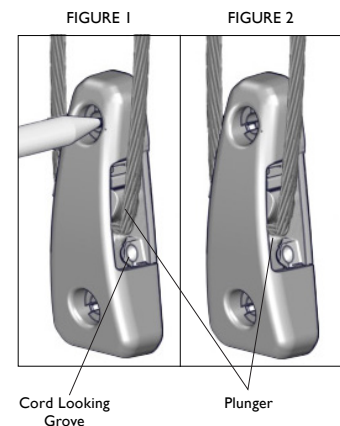

PANEL SYSTEM INSTALLATION INSTRUCTIONS (continued)

SIMPLY FOLLOW OUR STEP-BY-STEP INSTRUCTIONS AND YOUR BEAUTIFUL NEW SHADES WILL SOON BE ENHANCING YOUR HOME OR WORKSPACE FOR MANY YEARS TO COME.

4b. Installing Tension Device Only

Attach tension device to wall by installing larger provided screws into tension device holes. (Figure 3)

FIGURE 3

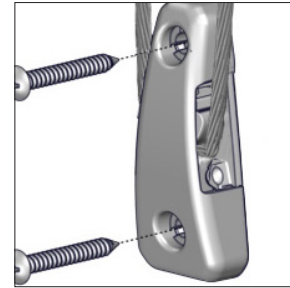

Inside Mount

4c. Using A Bracket:

Remove tension device to reveal pencil marks. Align mounting bracket notches (Figure 4A, 5A) over pencil marks.

Next, attach bracket to wall by installing larger provided screws into mounting bracket oval slots.

Press the tension device onto the mounting bracket posts (Figure 4A, 5A). Carefully install the 2 small screws provided, through the tension device into the mounting bracket using a Phillips head screwdriver (Figure 4B, 5B)

FIGURE 4A

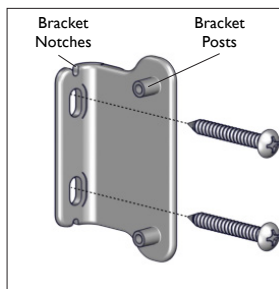

Outside Mount with Bracket

FIGURE 4B

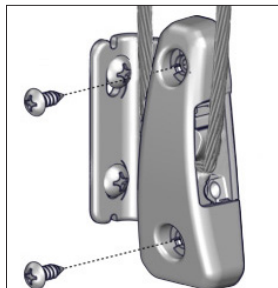
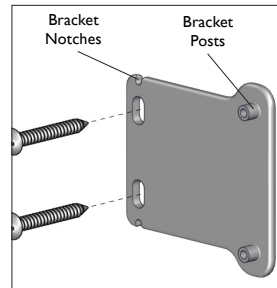
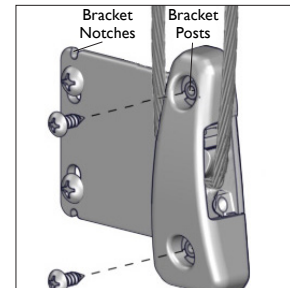

FIGURE 5A



Side Mount with Bracket

FIGURE 5B



Installing Baton (Baton Control Only):

You may attach the baton(s) to the rear of the lead panel(s). Simply fit the metal hook on the baton through the slot on the back of the leading panel(s).



Care and Cleaning:

Minimal care and cleaning is needed to maintain the beauty of your shades. To vacuum: Use a hand held, low suction vacuum. To dust: Use a soft, clean cloth or a feather duster.

Warranty:

The Shade Store products are covered by a limited lifetime warranty. This warranty covers any defects in materials or workmanship so long as the product is measured and installed according to instructions. Every Shade Store window treatment is designed to provide trouble-free use. In the unlikely event that warranty service is ever needed, simply contact the Help Desk at help@theshadestore.com or 800-754-1455 for assistance.

THIS PAGE
INTENTIONALLY
LEFT BLANK