

ROLLER + SOLAR ROLLER SHADES INSTALLATION INSTRUCTIONS

SIMPLY FOLLOW OUR STEP-BY-STEP INSTRUCTIONS AND YOUR BEAUTIFUL NEW SHADES WILL SOON BE ENHANCING YOUR HOME OR WORKSPACE FOR MANY YEARS TO COME.

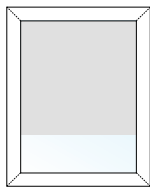
Getting Started:

Carefully unpack your shades and check to make sure you have the following installation parts. We recommend reading through these instructions before starting the installation.

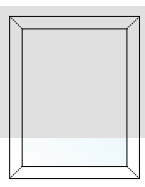
Parts Included:

- Screws
- Two mounting brackets
- Tension Device

Please note that your brackets must be securely attached to the mounting surface. If your screws do not hit wood studs you'll have to use a different fastener which can be found at any local hardware store.



INSIDE MOUNT



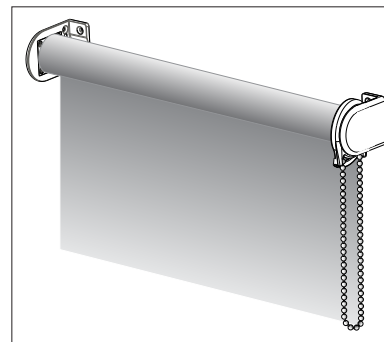
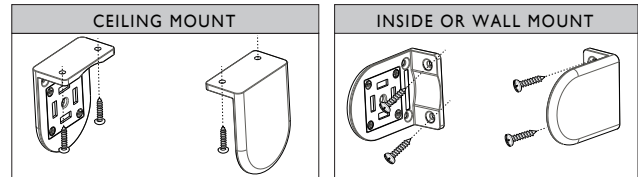
OUTSIDE MOUNT

Tools You Will Need:

- Drill with a 1/8" bit & a Phillips bit
- Phillips screwdriver
- Metal tape measure

* According to the Window Covering Manufacturers Association Inc., all labels must not be removed from the product.

* To comply with child safety standards, all tension devices must be installed per the installation instructions provided in step 3



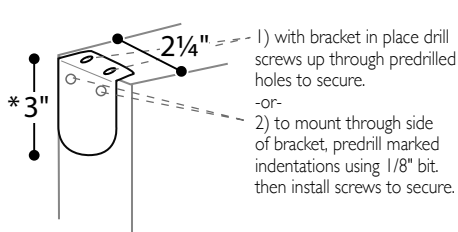
SHOWN AS REGULAR ROLL

I A. Installing Your Brackets:

Inside Mount: Attach the brackets to the window frame, window molding, wall or ceiling, as shown. Brackets are universal so clutch may be mounted on either side. There are 5 easy ways to install brackets. Choose which is best suited for your situation.

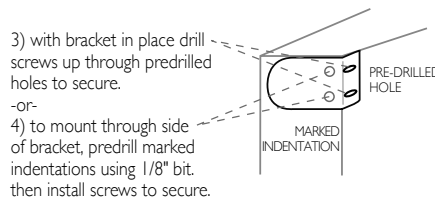
Proceed to step 2

INSTALL BRACKETS UPWARD



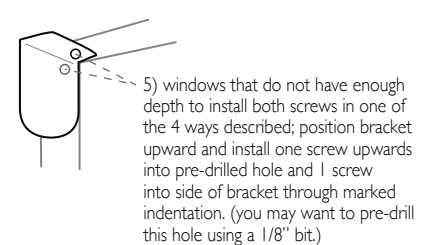
- 1) with bracket in place drill screws up through predrilled holes to secure.
- or-
- 2) to mount through side of bracket, predrill marked indentations using 1/8" bit, then install screws to secure.

INSTALL BRACKETS STRAIGHT ON



- 3) with bracket in place drill screws up through predrilled holes to secure.
- or-
- 4) to mount through side of bracket, predrill marked indentations using 1/8" bit, then install screws to secure.

SHALLOW DEPTH BRACKET INSTALLATION



- 5) windows that do not have enough depth to install both screws in one of the 4 ways described; position bracket upward and install one screw upwards into pre-drilled hole and 1 screw into side of bracket through marked indentation. (you may want to pre-drill this hole using a 1/8" bit.)

* Please note for thicker fabrics or longer lengths, we may provide an "extension" bracket to accommodate a larger roll diameter. In this case, the measurement from the "foot" to the curved area of the bracket would be 3 3/4".

ROLLER + SOLAR ROLLER SHADES INSTALLATION INSTRUCTIONS (continued)

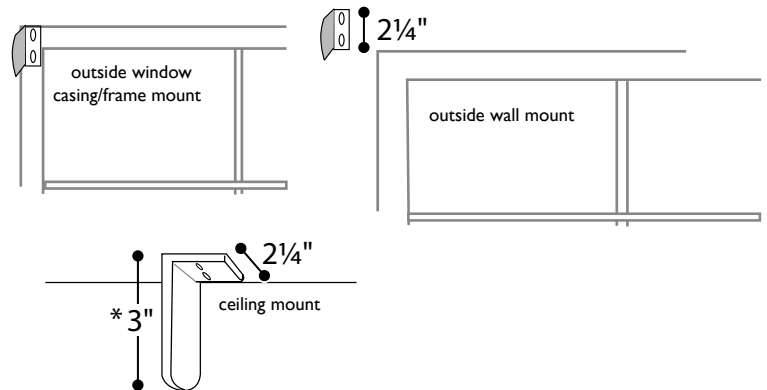
SIMPLY FOLLOW OUR STEP-BY-STEP INSTRUCTIONS AND YOUR BEAUTIFUL NEW SHADES WILL SOON BE ENHANCING YOUR HOME OR WORKSPACE FOR MANY YEARS TO COME.

1B. Installing Your Brackets:

Outside Mount: Fit the shade into the brackets and center the shade over the window (this may take two people). With a pencil mark the wall on the side of one bracket. Remove shade and then attach the one bracket with two screws. Next, insert the shade into the second bracket. Hold shade up and insert other end into the already mounted bracket making sure that the shade is level. Mark the wall on the side of the second bracket. Remove shade, install second bracket with two screws.

Proceed to step 2

* Please note for thicker fabrics or longer lengths, we may provide an "extension" bracket to accommodate a larger roll diameter. In this case, the measurement from the "foot" to the curved area of the bracket would be $3\frac{3}{4}$ ".



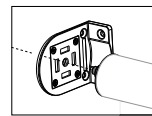
2. Inserting the Shade:

With the brackets now installed, you may install your shade.

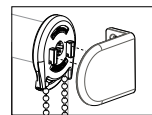
Step A: Put the spring loaded pin end into the round hole of the bracket. Pushing the pin end towards its bracket, insert the hooks on the clutch side straight into the two slots in the bracket.

Step B: Once the two hooks are through the slots, gently pull down on the clutch until the two hooks have locked securely to the bracket. The bottom of the clutch should point straight down.

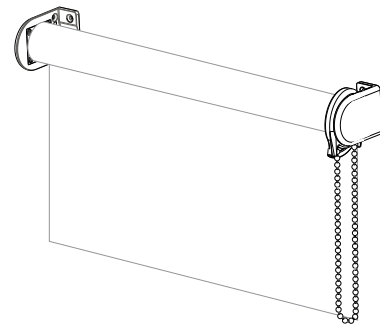
* Please note: Roller shades are not meant to be lowered past the ordered length. The shade will come with additional material that is automatically added in length to conceal the roller tube and to help secure the fabric on the roll. We have attached metal ball stops on the chain to prevent the shade from being raised or lowered past its limits.



STEP A



STEP B



SHOWN AS REGULAR ROLL

3. Installing Tension Device (Continuous Loop Control):

Positioning Tension Device:

The tension device should be positioned on the window frame or the wall so that the tension device and bead chain does not interfere with operation of window treatment.

3a. Begin Installation: First slide the tension device to the bottom of the bead chain.

While holding the tension device in one hand, pull the plunger away from the bead chain with the other hand. Lift the bead chain out of the bead locking groove (Figure 1) and slide the tension device to the bottom of the chain loop.

Pull the tension device down until the bead chain is fully tensioned (plunger [Figure 2] will be at the top) and then move the tension device up approximately $\frac{1}{8}$ " (3mm).

Mark the screw hole locations on the wall with a pencil. (Figure 1)

Please Note: When attaching to wood, included screws can be screwed directly into wood. When attaching to drywall and metal, use anchors that are designed for such substrates. Visit your local hardware store for guidance on appropriate anchors for your substrate.

Continue to 3b. when installing tension device only or 3c. if installing with bracket.



ROLLER + SOLAR ROLLER SHADES INSTALLATION INSTRUCTIONS (continued)

SIMPLY FOLLOW OUR STEP-BY-STEP INSTRUCTIONS AND YOUR BEAUTIFUL NEW SHADES WILL SOON BE ENHANCING YOUR HOME OR WORKSPACE FOR MANY YEARS TO COME.

3b. Installing Tension Device Only

Attach tension device to wall by installing larger provided screws into tension device holes. (Figure 3)

FIGURE 3



Inside Mount

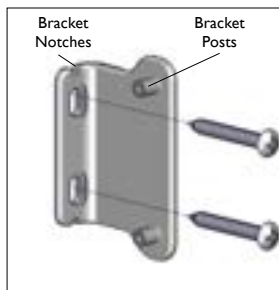
3c. Using A Bracket:

Remove tension device to reveal pencil marks. Align mounting bracket notches (Figure 4A, 5A) over pencil marks.

Next, attach bracket to wall by installing larger provided screws into mounting bracket oval slots.

Press the tension device onto the mounting bracket posts (Figure 4A, 5A). Carefully install the 2 small screws provided, through the tension device into the mounting bracket using a Phillips head screwdriver (Figure 4B, 5B)

FIGURE 4A

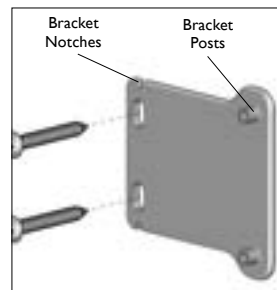


Outside Mount with Bracket

FIGURE 4B

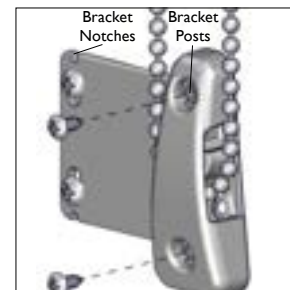


FIGURE 5A



Side Mount with Bracket

FIGURE 5B



Care and Cleaning:

Minimal care and cleaning is needed to maintain the beauty of your shades. To vacuum: Use a hand held, low suction vacuum. To dust: Use a soft, clean cloth or a feather duster.

Warranty:

The Shade Store products are covered by a limited lifetime warranty. This warranty covers any defects in materials or workmanship so long as the product is measured and installed according to instructions. Every Shade Store window treatment is designed to provide trouble-free use. In the unlikely event that warranty service is ever needed, simply contact the Help Desk at help@theshadestore.com or 800-754-1455 for assistance.

ROLLER + SOLAR SHADES WITH METAL VALANCE INSTALLATION INSTRUCTIONS

SIMPLY FOLLOW OUR STEP-BY-STEP INSTRUCTIONS AND YOUR BEAUTIFUL NEW SHADES WILL SOON BE ENHANCING YOUR HOME OR WORKSPACE FOR MANY YEARS TO COME.

Getting Started:

Carefully unpack your shades and check to make sure you have the following installation parts. We recommend reading through these instructions before starting the installation.

Parts Included:

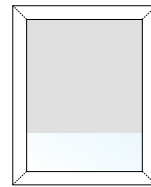
- Screws
- Mounting brackets
- Tension Device

Tools You Will Need:

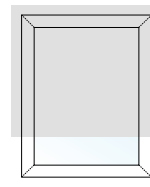
- Drill with a 1/8" bit & a Phillips bit
- Phillips screwdriver
- Metal tape measure

* According to the Window Covering Manufacturers Association Inc., all labels must not be removed from the product.

* To comply with child safety standards, all tension devices must be installed per the installation instructions provided in step 3.



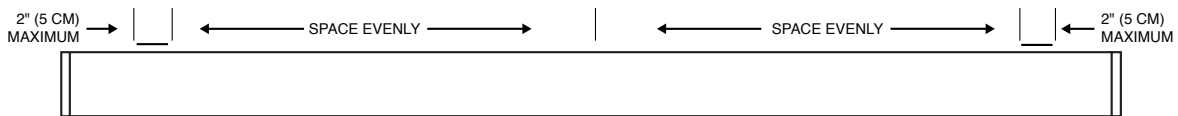
INSIDE MOUNT



OUTSIDE MOUNT

I. Select Mount Type:

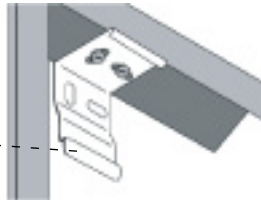
Mount the brackets to the wall or window frame, with the outside brackets no further than 2 inches (5 cm) from the ends of the headrail. On wide shades, space the additional bracket(s) at equal intervals.



Inside Mount:

For inside or ceiling mounts, use the top bracket holes.

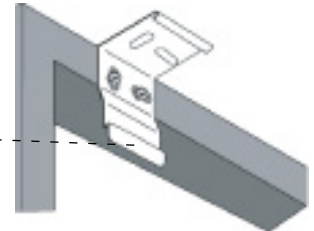
Make sure the release tab is always mounted on the bottom.



Outside Mount:

For wall or outside mounts, use the rear bracket holes.

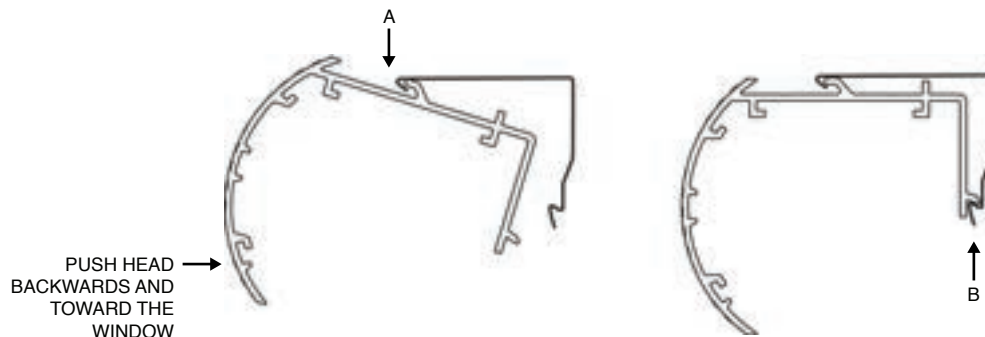
Make sure the release tab is always mounted on the bottom.



Please note that your brackets must be securely attached to the mounting surface. If your screws do not hit wood studs you'll have to use a different fastener which can be found at any local hardware store.

2. Mount the Headrail:

Position the headrail with the front panel (A) resting on the top lip of all brackets. Push the bottom front of the headrail firmly backwards and toward the window until the lip on the rear of the headrail engages the bracket and snaps into place, (B) as shown.



Please note: Roller shades are not meant to be lowered past the ordered length. The shade will come with additional material that is automatically added in length to conceal the roller tube and to help secure the fabric on the roll. We have attached metal ball stops on the chain to prevent the shade from being raised or lowered past its limits.

ROLLER + SOLAR SHADES WITH METAL VALANCE INSTALLATION INSTRUCTIONS

SIMPLY FOLLOW OUR STEP-BY-STEP INSTRUCTIONS AND YOUR BEAUTIFUL NEW SHADES WILL SOON BE ENHANCING YOUR HOME OR WORKSPACE FOR MANY YEARS TO COME (CONTINUED)

3. Installing Tension Device (Continuous Loop Control):

Positioning Tension Device:

The tension device should be positioned on the window frame or the wall so that the tension device and bead chain does not interfere with operation of window treatment.

3a. Begin Installation:

First slide the tension device to the bottom of the bead chain. While holding the tension device in one hand, pull the plunger away from the bead chain with the other hand. Lift the bead chain out of the bead locking groove (Figure 1) and slide the tension device to the bottom of the chain loop.

Pull the tension device down until the bead chain is fully tensioned (plunger [Figure 2] will be at the top) and then move the tension device up approximately 1/8" (3mm).

Mark the screw hole locations on the wall with a pencil. (Figure 1)

Please Note: When attaching to wood, included screws can be screwed directly into wood. When attaching to drywall and metal, use anchors that are designed for such substrates. Visit your local hardware store for guidance on appropriate anchors for your substrate.

Continue to 3b. when installing tension device only or 3c. if installing with bracket.

3b. Installing Tension Device Only

Attach tension device to wall by installing larger provided screws into tension device holes. (Figure 3)

3c. Using A Bracket:

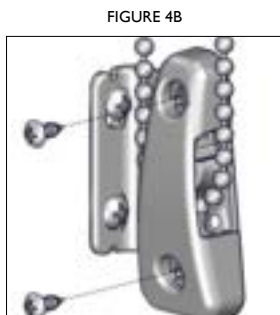
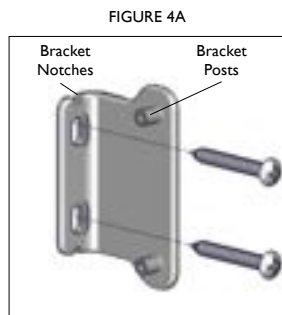
Remove tension device to reveal pencil marks. Align mounting bracket notches (Figure 4A, 5A) over pencil marks.

Next, attach bracket to wall by installing larger provided screws into mounting bracket oval slots.

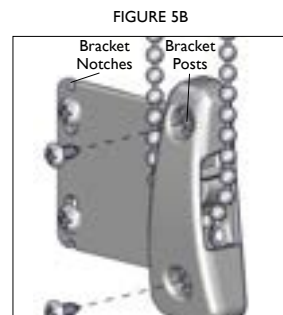
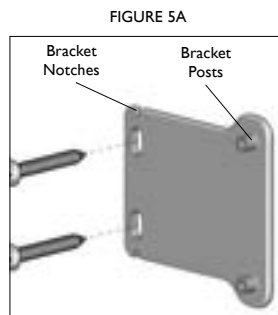
Press the tension device onto the mounting bracket posts (Figure 4A, 5A). Carefully install the 2 small screws provided, through the tension device into the mounting bracket using a Phillips head screwdriver (Figure 4B, 5B)



Inside Mount



Outside Mount with Bracket



Side Mount with Bracket

Care and Cleaning:

Minimal care and cleaning is needed to maintain the beauty of your shades. To vacuum: Use a hand held, low suction vacuum. To dust: Use a soft, clean cloth or a feather duster.

Warranty:

The Shade Store products are covered by a limited lifetime warranty. This warranty covers any defects in materials or workmanship so long as the product is measured and installed according to instructions. Every Shade Store window treatment is designed to provide trouble-free use. In the unlikely event that warranty service is ever needed, simply contact the Help Desk at help@theshadestore.com or 800-754-1455 for assistance.

ROLLER+SOLAR SHADES WITH UPHOLSTERED VALANCE INSTALL INSTRUCTIONS

SIMPLY FOLLOW OUR STEP-BY-STEP INSTRUCTIONS AND YOUR BEAUTIFUL NEW SHADES WILL SOON BE ENHANCING YOUR HOME OR WORKSPACE FOR MANY YEARS TO COME.

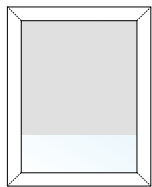
Getting Started:

Carefully unpack your shades and check to make sure you have the following installation parts. We recommend reading through these instructions before starting the installation.

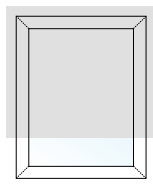
Parts Included:

- Screws
- “L” brackets (outside mount)
- Tension Device

Please note that your brackets must be securely attached to the mounting surface. If your screws do not hit wood studs you'll have to use a different fastener which can be found at any local hardware store.



INSIDE MOUNT



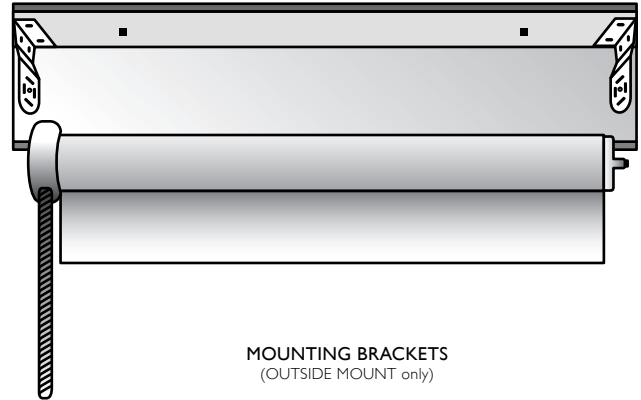
OUTSIDE MOUNT

Tools You Will Need:

- Drill with a 1/8" bit & a Phillips bit
- Phillips screwdriver
- Metal tape measure

* According to the Window Covering Manufacturers Association Inc., all labels must not be removed from the product.

* To comply with child safety standards, all tension devices must be installed per the installation instructions provided in step 3.



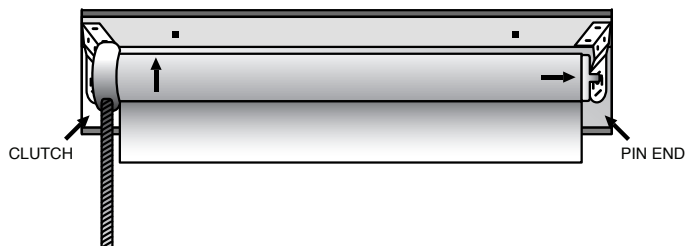
IA. Mounting Your Roller/Solar Shades with Upholstered Valance:

Inside Mount:

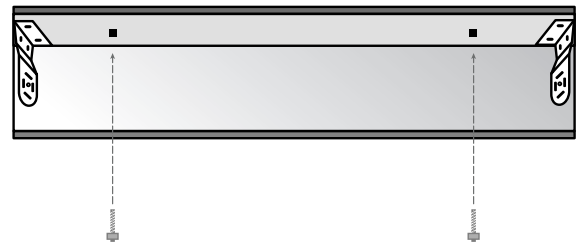
Installing the valance: The mounting holes are pre-drilled through the headrail / top of upholstered valance. (No “L” brackets needed for inside mount)

Please note: The pre-drilled holes may not be ideal for all install scenarios – if needed, you may pre-drill new holes as desired.

The shade and brackets come pre-mounted into the upholstered valance. Before installing the valance, remove the shade from the brackets. To remove, lift the chain side up of the shade slightly and push the roller in the direction of the opposite bracket.



Start the screws in to the mounting holes and tighten until the tips of the screws are slightly showing on the top of the headrail. Hold the valance inside the window frame. With the valance properly positioned, push up on the headrail (top) of the valance allowing the screw tips to leave a small indentation on the window frame. Now drill a hole with an 1/8" drill bit at the indentations. Finish the job by drilling the screws in the headrail into the pre-drilled holes to secure the valance in place.

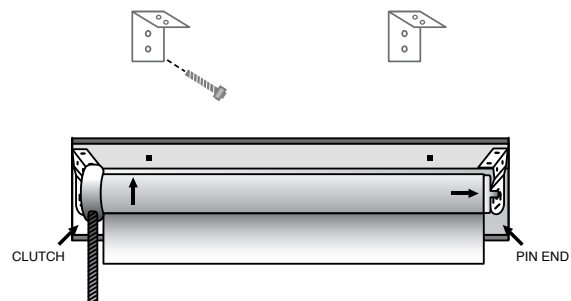


IB. Mounting Your Roller /Solar Shades with Upholstered Valance:

Outside Mount:

Install the brackets: The valance will be hung /attached to the window frame or wall with the “L” brackets included. Attach the brackets to the wall or window frame at the desired height. Attach the brackets using the long screws provided, making sure the brackets are level with each other.

The shade and brackets come pre-mounted into the upholstered valance. Before installing the valance, remove the shade from the brackets. To remove, lift the chain side up of the shade slightly and push the roller in the direction of the opposite bracket.

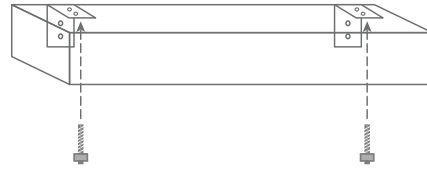


ROLLER+SOLAR SHADES WITH UPHOLSTERED VALANCE INSTALL INSTRUCTIONS

SIMPLY FOLLOW OUR STEP-BY-STEP INSTRUCTIONS AND YOUR BEAUTIFUL NEW SHADES WILL SOON BE ENHANCING YOUR HOME OR WORKSPACE FOR MANY YEARS TO COME. (CONTINUED)

1.C. Mounting Your Roller /Solar Shades with Upholstered Valance:

Install the valance: Set the headrail /top of valance on the brackets. Center the valance against the wall or window frame. Mark hole and pre-drill using a 1/8" drill bit at each bracket location. Attach the upholstered valance to the brackets using the short screws provided.



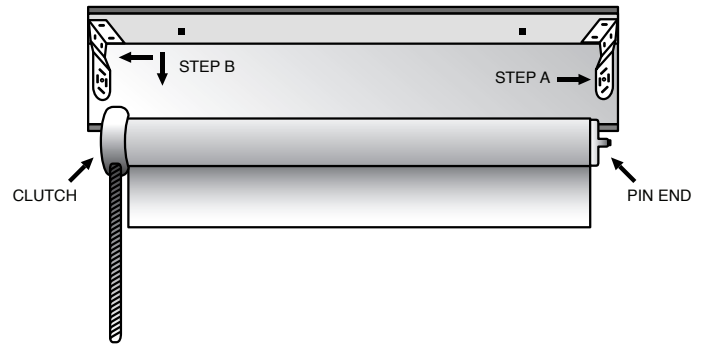
2. Inserting the Shade:

With the valance now installed, you may install your shade into the pre-mounted brackets on the sides of the valance:

Step A: Put the spring loaded pin end into the round hole of the bracket. Pushing the pin end towards its bracket, insert the hooks on the clutch side straight into the two slots in the bracket.

Step B: Once the two hooks are through the slots, gently pull down on the clutch until the two hooks have locked securely to the bracket. The bottom of the clutch should point straight down.

Please note: Roller shades are not meant to be lowered past the ordered length. The shade will come with additional material that is automatically added in length to conceal the roller tube and to help secure the fabric on the roll. We have attached metal ball stops on the chain to prevent the shade from being raised or lowered past its limits.



3. Installing Tension Device (Continuous Loop Control):

Positioning Tension Device:

The tension device should be positioned on the window frame or the wall so that the tension device and bead chain does not interfere with operation of window treatment.

3a. Begin Installation: First slide the tension device to the bottom of the bead chain.

While holding the tension device in one hand, pull the plunger away from the bead chain with the other hand. Lift the bead chain out of the bead locking groove (Figure 1) and slide the tension device to the bottom of the chain loop.

Pull the tension device down until the bead chain is fully tensioned (plunger [Figure 2] will be at the top) and then move the tension device up approximately 1/8" (3mm).

Mark the screw hole locations on the wall with a pencil. (Figure 1)

Please Note: When attaching to wood, included screws can be screwed directly into wood. When attaching to drywall and metal, use anchors that are designed for such substrates. Visit your local hardware store for guidance on appropriate anchors for your substrate.

Continue to 3b. when installing tension device only or 3c. if installing with bracket.



ROLLER+SOLAR SHADES WITH UPHOLSTERED VALANCE INSTALL INSTRUCTIONS

SIMPLY FOLLOW OUR STEP-BY-STEP INSTRUCTIONS AND YOUR BEAUTIFUL NEW SHADES WILL SOON BE ENHANCING YOUR HOME OR WORKSPACE FOR MANY YEARS TO COME. (CONTINUED)

3b. Installing Tension Device Only

Attach tension device to wall by installing larger provided screws into tension device holes. (Figure 3)

FIGURE 3



Inside Mount

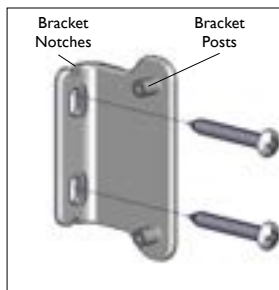
3c. Using A Bracket:

Remove tension device to reveal pencil marks. Align mounting bracket notches (Figure 4A, 5A) over pencil marks.

Next, attach bracket to wall by installing larger provided screws into mounting bracket oval slots.

Press the tension device onto the mounting bracket posts (Figure 4A, 5A). Carefully install the 2 small screws provided, through the tension device into the mounting bracket using a Phillips head screwdriver (Figure 4B, 5B)

FIGURE 4A

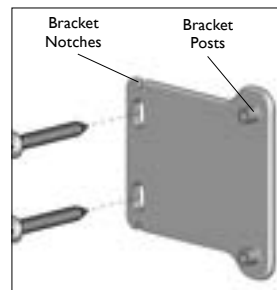


Outside Mount with Bracket

FIGURE 4B

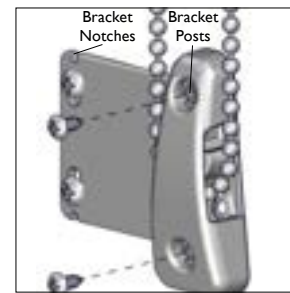


FIGURE 5A



Side Mount with Bracket

FIGURE 5B



Care and Cleaning:

Minimal care and cleaning is needed to maintain the beauty of your shades. To vacuum: Use a hand held, low suction vacuum. To dust: Use a soft, clean cloth or a feather duster.

Warranty:

The Shade Store products are covered by a limited lifetime warranty. This warranty covers any defects in materials or workmanship so long as the product is measured and installed according to instructions. Every Shade Store window treatment is designed to provide trouble-free use. In the unlikely event that warranty service is ever needed, simply contact the Help Desk at help@theshadestore.com or 800-754-1455 for assistance.

CORDLESS ROLLER SHADE WITH INSTALLATION INSTRUCTIONS

SIMPLY FOLLOW OUR STEP-BY-STEP INSTRUCTIONS AND YOUR BEAUTIFUL NEW SHADES WILL SOON BE ENHANCING YOUR HOME OR WORKSPACE FOR MANY YEARS TO COME.

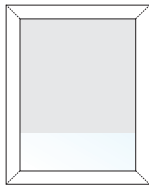
Getting Started:

Carefully unpack your shades and check to make sure you have the following installation parts. We recommend reading through these instructions before starting the installation.

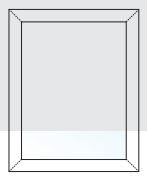
Parts Included:

- Screws
- Mounting brackets & covers (AA only).
- Tension adjustment tool

Please note that your brackets must be securely attached to the mounting surface. If your screws do not hit wood studs you'll have to use a different fastener which can be found at any local hardware store.



INSIDE MOUNT

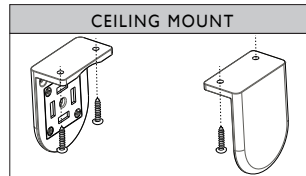


OUTSIDE MOUNT

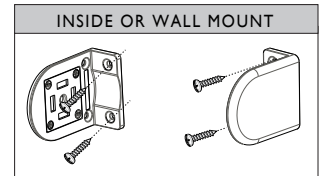
Tools You Will Need:

- Drill with a 1/8" bit & a Phillips bit
- Phillips screwdriver
- Metal tape measure
- Pencil

* According to the Window Covering Manufacturers Association Inc., all labels must not be removed from the product. All tension devices must be installed per the installation instructions provided in step 3.



CEILING MOUNT



INSIDE OR WALL MOUNT

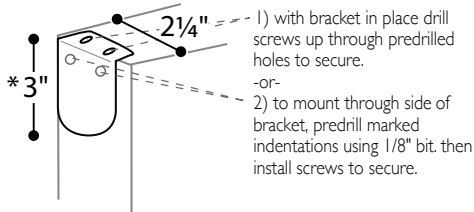
Make sure that you are mounting to a level surface. If your shade does not sit level, the fabric will not roll up evenly which could damage the edges of the fabric.

I.A. Installing Your Brackets:

Inside Mount: Attach the brackets to the window frame, window molding, wall or ceiling, as shown. Brackets are universal however, the tension spring must be installed on the left facing side of the window with the orange stopper attached during installation. You must have a minimum window depth of 1" to mount inside the window jamb.

Proceed to step 2

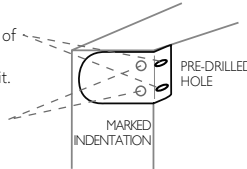
INSTALL BRACKETS UPWARD



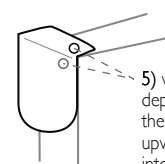
- 1) with bracket in place drill screws up through predrilled holes to secure.
- or-
- 2) to mount through side of bracket, predrill marked indentations using 1/8" bit. then install screws to secure.

INSTALL BRACKETS STRAIGHT ON

- 3) to mount through side of bracket, predrill marked indentations using 1/8" bit. then install screws to secure.



SHALLOW DEPTH BRACKET INSTALLATION



- 5) windows that do not have enough depth to install both screws in one of the 4 ways described; position bracket upward and install one screw upwards into predrilled hole and 1 screw into side of bracket through marked indentation. (you may want to predrill this hole using a 1/8" bit.)

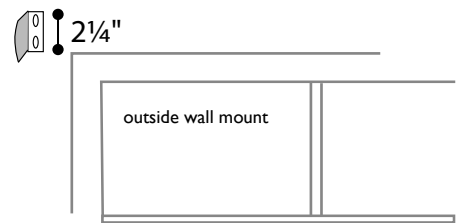
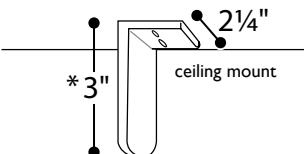
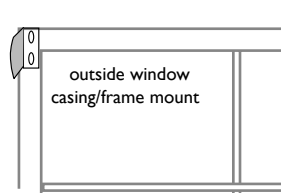
* Please note for thicker fabrics or longer lengths, we may provide an "extension" bracket to accommodate a larger roll diameter. In this case, the measurement from the "foot" to the curved area of the bracket would be 3 3/4".

I.B. Installing Your Brackets:

Outside Mount: Fit the shade into the brackets and center the shade over the window (this may take two people). With a pencil mark the wall on the side of one bracket. Remove shade and then attach the one bracket with two screws. Next, insert the shade into the second bracket. Hold shade up and insert other end into the already mounted bracket making sure that the shade is level. Mark the wall on the side of the second bracket. Remove shade, install second bracket with two screws.

Proceed to step 2

* Please note for thicker fabrics or longer lengths, we may provide an "extension" bracket to accommodate a larger roll diameter. In this case, the measurement from the "foot" to the curved area of the bracket would be 3 3/4".



CORDLESS ROLLER SHADE INSTALLATION INSTRUCTIONS CONTINUED

SIMPLY FOLLOW OUR STEP-BY-STEP INSTRUCTIONS AND YOUR BEAUTIFUL NEW SHADES WILL SOON BE ENHANCING YOUR HOME OR WORKSPACE FOR MANY YEARS TO COME.

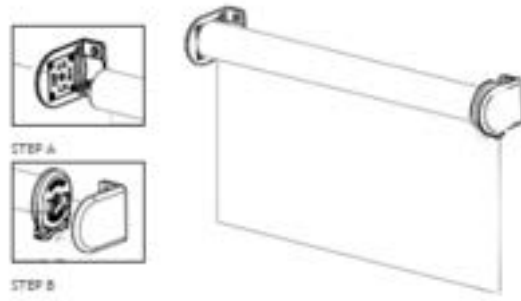
2. Inserting the Shade:

With the brackets now installed, you may install your shade.

Step A: Put the spring loaded pin end into the round hole of the bracket. Pushing the pin end towards its bracket, insert the hooks on the clutch side straight into the two slots in the bracket.

Step B: Once the two hooks are through the slots, gently pull down on the clutch until the two hooks have locked securely to the bracket. The bottom of the clutch should point straight down.

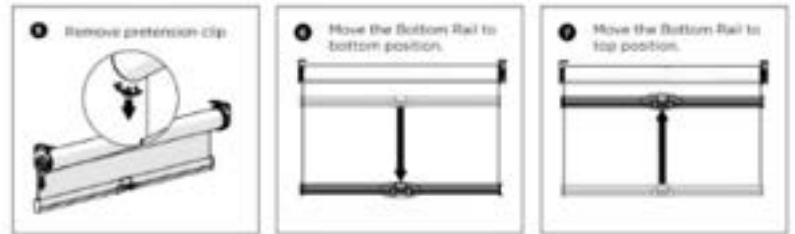
* Please note: Roller shades are not meant to be lowered past the ordered length. The shade will come with additional material that is automatically added in length to conceal the roller tube and to help secure the fabric on the roll. We have attached metal ball stops on the chain to prevent the shade from being raised or lowered past its limits.



SHOWN AS REGULAR ROLL

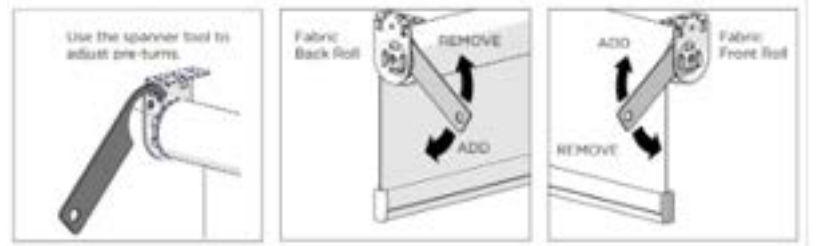
3. Unlock and Test the Shade:

- Unlock shade and test to ensure that it is not moving on it's own
- Remove the pretension clip
- Pull the bottom of the shade down to the bottom position
- Move the bottom of the shade to the top position



4. Adjusting The Tension On Your Shade:

- Locate the Spanner Tool
- Align the tool to the clutch on the left side of the shade
- Turn the clutch clockwise to add tension to the shade; this will help improve the shade retraction
- Test the shade
- Repeat until the shade works properly
- If you add too much tension, turn the clutch counterclockwise to reduce the tension level



Warranty:

The Shade Store products are covered by a limited lifetime warranty. This warranty covers any defects in materials or workmanship so long as the product is measured and installed according to instructions. Every Shade Store window treatment is designed to provide trouble-free use. In the unlikely event that warranty service is ever needed, simply contact customer care at help@theshadestore.com or 800-754-1455 for assistance.